

TVS Diodes - Transient Voltage Suppressors LV Ethernet Gig Protection 30A 1.5pF

Manufacturers	STMicroelectronics, Inc
Package/Case	SO-8
Product Type	TVS Diodes
RoHS	Rohs
Lifecycle	

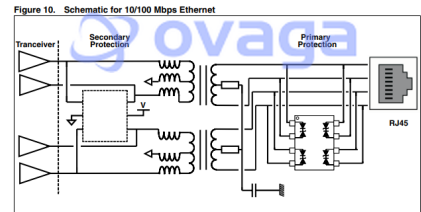
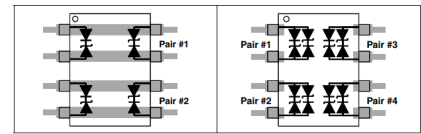

Images are for reference only

Please submit RFQ for SLVU2.8-4A1 or [Email to us: sales@ovaga.com](mailto:sales@ovaga.com) We will contact you in 12 hours.

[RFQ](#)

General Description

Ovaga has a large stock of SLVU2.8-4A1 TVS Diodes from STMicroelectronics, Inc and we guarantee that they are original, brand new parts sourced directly from STMicroelectronics, Inc We can provide quality testing reports for SLVU2.8-4A1 upon your request. To obtain a quote, simply fill in the required quantity, contact name, and email address in the quick quote form on the right. Our sales representative will contact you within 12 hours.

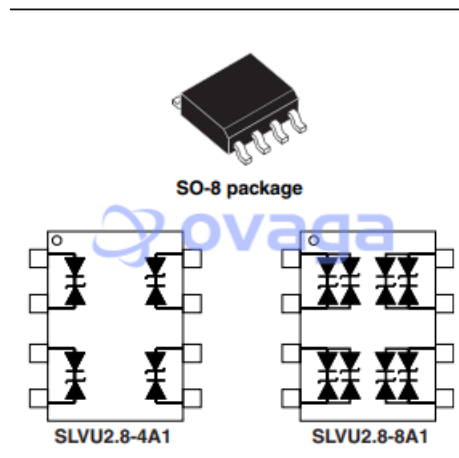
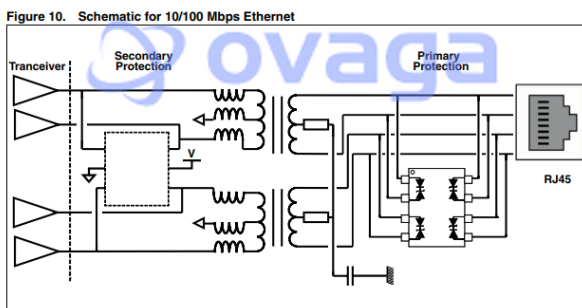
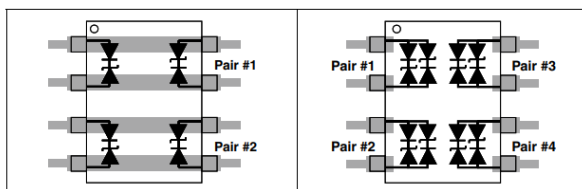

Related Products

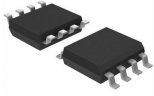

[SLVU2.8-8A1](#)

STMicroelectronics, Inc
SO-8



[P6KE440A](#)

STMicroelectronics, Inc
DO-204AC

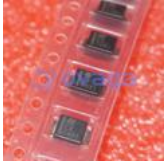

[SM6T39A](#)

STMicroelectronics, Inc
DO-214AA

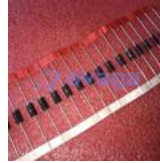

[1.5KE27A](#)

STMicroelectronics, Inc
DO-201AD



[SMAJ6.0A-TR](#)

STMicroelectronics, Inc
DO-214AC



[SMCJ40CA-TR](#)

STMicroelectronics, Inc
DO-214AB



[SMBJ5.0CA-TR](#)

STMicroelectronics, Inc
DO-214AA

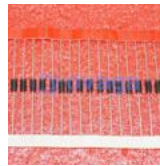

[P6KE6V8A](#)

STMicroelectronics, Inc
DO-15