

Pressure Sensor 0.2V to 4.7V 0kPa to 10kPa Gage Automotive 8-Pin PDIP Tube

Manufacturers	NXP Semiconductor
Package/Case	DIP-8
Product Type	Pressure Sensors
RoHS	Rohs
Lifecycle	

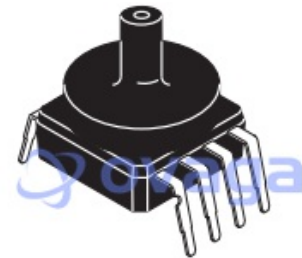

**MPXV5010GC7U
CASE 482C-03**

Images are for reference only

Please submit RFQ for MPXV5010GC7U or [Email to us: sales@ovaga.com](mailto:sales@ovaga.com) We will contact you in 12 hours.

[RFQ](#)

General Description

Features

Pressure Sensor, 5V, 0/10kPa, Sensor 8

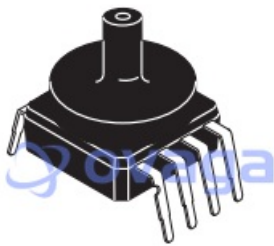

**MPXV5010GC7U
CASE 482C-03**

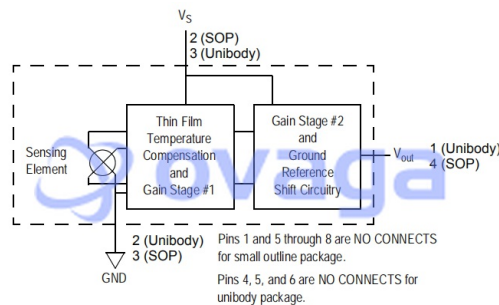
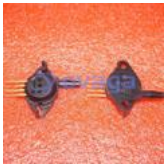

Figure 1. Fully Integrated Pressure Sensor Schematic

Related Products



[MPX10GP](#)

NXP Semiconductor
SIP-4



[MPXM2102A](#)

NXP Semiconductor
M-PAK-5

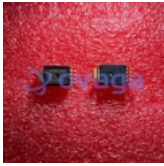

[MPXM2202D](#)

NXP Semiconductor
M-PAK-5

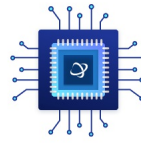

[MPX2100A](#)

NXP Semiconductor
Unibody 4-pin

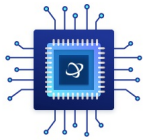

[MPX2100D](#)

NXP Semiconductor
Unibody 4-pin



[MPX5100D](#)

NXP Semiconductor
SIP-6

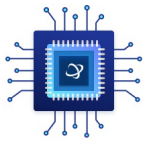

[MPX5700GS](#)

NXP Semiconductor
Unibody 6-pin

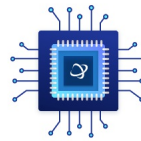

[MPXV2202GP](#)

NXP Semiconductor
M-PAK-5